



*State-of-the-art filter backflush controller*

## *OWNER'S MANUAL*

***For the TurboDisc Air Assist Product Line***



## Introduction

Thank you for purchasing the *MAXIM*, a state-of-the-art backwash controller designed for automatic filtration systems. The heart of the *MAXIM* is a programmable micro PLC, custom designed to maximize the performance of your filtration system. These components are protected by a robust, corrosion-proof watertight enclosure. The *MAXIM* has a user-friendly, menu driven controller that gives the user control of all critical automatic filter functions. The backlit LCD display provides real-time system status. The memory module (EEPROM) allows for installation of system upgrades and provides the ability to download custom, application specific programs without the need for a computer. Please read this manual prior to installation and retain it for future reference.

## Contents

1) Installation .....	2
2) Electrical Detail.....	3
3) Viewing the Menu Screens & Adjusting Values.....	4
4) Monitoring System Status and Initiating a Backflush.....	4
5) Adjustable Values.....	5
6) Controller Feedback .....	6
7) Limited Warranty.....	6

## Installation

Some *MAXIM* controllers are pre-installed as a component of a complete filtration system while others come as a stand-alone unit. Follow the directions below only if it is necessary to connect the electrical or gauge connections.

### Electrical Connections:

If the Maxim controller is not pre-wired as part of an automatic filter system, then it will be necessary to mount the controller on a flat surface using the mounting brackets provided. It will also be necessary to connect each filter station to a corresponding *Output (+)* and *Common (-)* terminal on the circuit board. Review the *Electrical Detail* section prior to making any connections to the controller. If requested custom input/output capabilities are not described in this manual, please refer to an attached addendum.

### Differential Pressure Gauge Connections:

Connect the pressure differential (PD) gauge to the system's inlet (high) and outlet (low) pressure ports.

**WARNING:** Failure to use a second wrench on the low pressure port when tightening fittings may result in damage to the internal pressure tubing.

Be sure all connection tubing is clean prior to installation on the gauge. The gauge contains orifices that may become clogged by larger particles.

**CAUTION:** Make sure not to foul the pressure orifices with pipe dope or dirt, as the gauge will not operate.

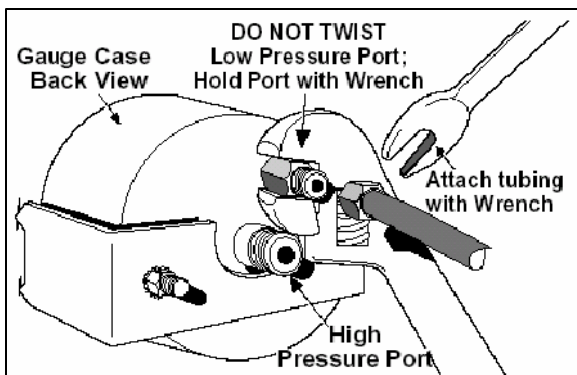
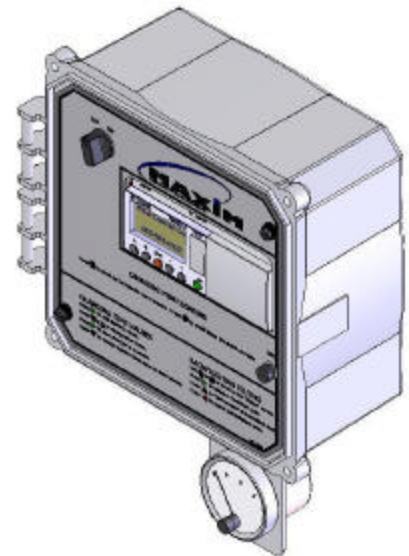

### Differential Pressure Gauge Set-point:

Adjust the contact to the desired PD set-point that will trigger a backflush cycle. The differential pressure switch-gauge contact should be set at the filter's recommended setting. Reference the filter manufacturer's owner's manual for the recommended PSID setting.

## Electrical Detail

The circuit board layout shown applies to the M4, M8, and M10 controllers. The M\_ in the serial number on the left side of the enclosure designates the controller's total number of outputs. For example, a MLI-M8-xxxxx has 8 available outputs (uses outputs 1-8 only, leaving outputs 9 and 10 unused). Review the connection details below before wiring to the controller.

**CAUTION: Unplug controller from power source before removing cover!**

### A. Power supply connections:

- *115VAC Power In* provides power to the transformer. The standard controller comes equipped with a 115VAC wall outlet plug. 115VAC can be hard-wired into these connections if preferred.
- *12VDC/24VDC/24VAC Power In* provides power to the controller and circuit board connections. This power is typically provided from the transformer. If 115VAC power is not available for the transformer, low voltage power can be provided directly into these connections (make sure to remove and cap any existing transformer wires). The provided power must match the controller's operating voltage (indicated directly above the LCD screen).

Note: The standard transformer provides a maximum total power output as listed below. Exceeding the maximum available power may trip the fuse repeatedly or overload the transformer. The fuse is an automatic resetting type and will reset itself within a few seconds of being tripped.

Maximum power available: 12VDC or 24VDC - 24 Watts; 24VAC - 48 Watts

### B. Outputs:

The outputs provide a voltage output (same as controller's voltage) to control the backflush valves, booster pump, solenoids, pressure sustaining valve, air override, etc. The last output is typically a *master output*, which remains on during the entire backflush cycle.

Note: Any *Common (-)* connection may be used for the common/negative terminals of the solenoids/valves.

### C. Inputs:

The inputs provide signals into the controller. Digital (on/off) inputs require a voltage input that matches the controller's operating voltage. Analog (0-10VDC, 0-20mA, 4-20mA) signals are available on 12VDC/24VDC powered controllers with the appropriate circuit board. Standard controller inputs are listed below. Additional inputs are available for customer specific programs designed by Miller-Leaman, Inc. These allow for additional features to be added (including signals from Pressure, Flow, and Level Sensors).

Standard Inputs:

- I1 (PD Gauge) - I1 and *Auxiliary Power Out (+)* are connected to Normally Open contacts on the PD gauge. Once the PD set-point is reached, the contacts will close and signal the controller.
- I2 (Remote Start/Stop) - I2 signals the backflush interval timer in the controller to run. This will allow the controller to backflush by time after the pre-set time period has passed. This input is commonly connected to a pump contactor, pressure switch, or flow meter. On some systems, a jumper is installed into I2. In this case, a relay/contactor can be installed in-line of the jumper wire to remotely start/stop the timer.

Note: The *Auxiliary Power Out (+)* connections may be used to provide power to sensors, etc. However, the power used must be considered as part of the maximum power available from the transformer.

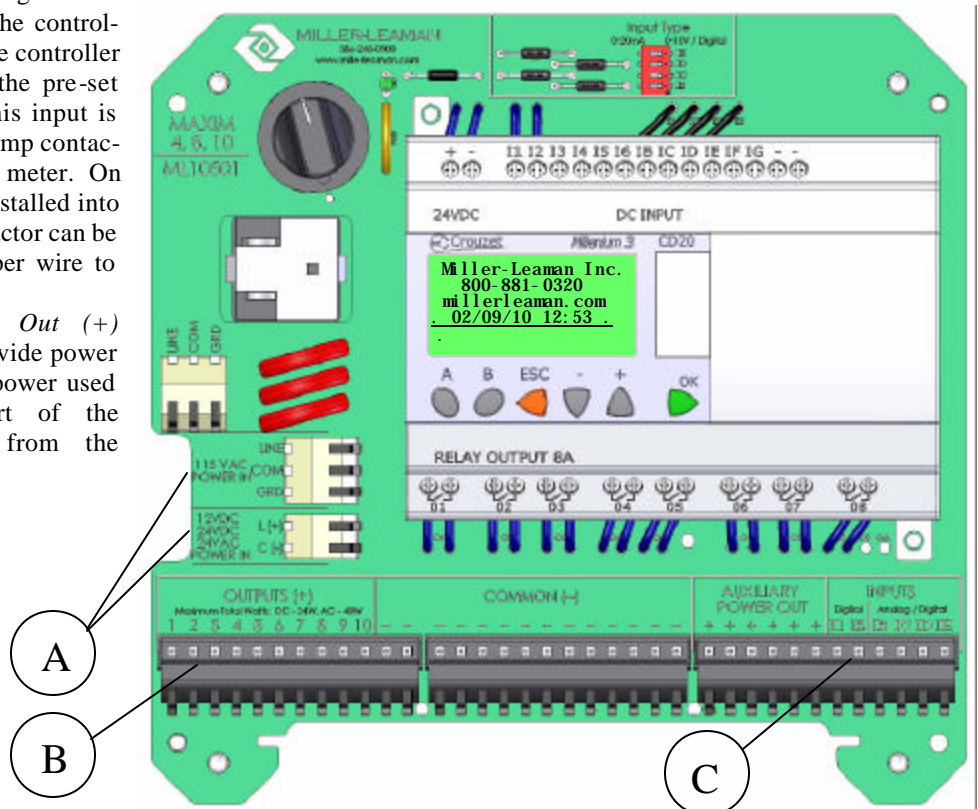

## Viewing the Menu Screens & Adjusting Values

### Scrolling through Menu Screens

The *MAXIM* controller allows the operator to scroll through a selection of menu screens by pressing the **A** or **B** buttons. Press **A** to scroll backward to the previous menu or press **B** to scroll forward to the next menu. The LCD backlight will automatically turn on for 5 minutes when a button is pressed, thus allowing the operator to easily view the menus in low light situations.

The next few pages describe the menus in the order they are seen by scrolling with the **B** button from the home screen. The home screen displays company contact information and is the default screen when the controller is turned on.

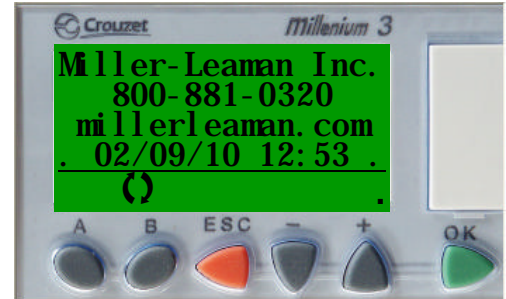

### Changing Values

To change an adjustable value, first scroll to the appropriate menu screen using the **A** or **B** button. Follow the directions below to modify the value.

1. The current selected value will show flashing blocks. Use the + or - keys to select another value if desired.
2. Press **OK** on the selected value. The value will change from flashing blocks to flashing numbers. (Flashing blocks indicate the value is locked into memory. Flashing numbers indicates the value is unlocked and can be changed.)
3. Press the + or - buttons to change the value. (Holding the + or - button will allow the value to increase at a faster rate after the first 10 increments have passed.)
4. When finished, press **OK** to save the change to memory. The value will return to flashing blocks.

## Monitoring the System Status & Initiating a Backflush

The Status Screen displays the current mode of the controller. It also allows the operator to manually start, stop or fast forward a backflush cycle. There are three ways that a backflush cycle can be initiated:

1. Manually, following the instructions below.
2. Automatically, by elapsed time (per the backflush frequency setting).
3. Automatically, by pressure differential (as set by the PD switch-gauge).

To initiate a manual backflush, press **OK** while on the status screen. To skip the current backflushing station, press + to “fast forward” to the next station. Note that holding the + button will hold the cycle in a dwell until it is released. At any time during the backflush cycle, press **ESC** to stop the cycle.

The current **Status** of the controller is displayed as follows:

1. **OFF** - Indicates that the backflush frequency timer is paused. The system will not backflush by the timer. There is assumed to be no flow going through the system. A backflush can still occur from a high pressure differential via the PD gauge or manually by the user. The controller displays **OFF** when there is no voltage input at *I2* on the controller.
2. **AUTO** - Indicates that the controller is awaiting for a backflush cycle to begin. The system is assumed to be in normal filtration mode and flowing water. The backflush frequency timer is running. The controller displays **AUTO** when there is a voltage input at *I2* on the controller.
3. **ON** - Indicates that the system is in backflush mode. The controller will also indicate which station is currently in a backflush or dwell.

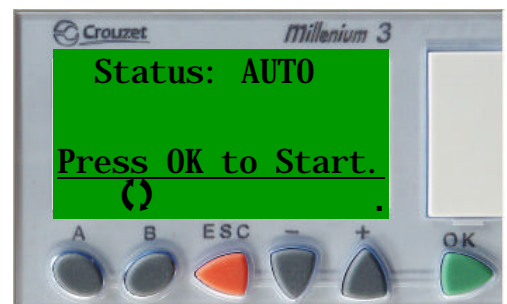

When the pressure differential set-point is reached, the controller will display **High PSID** for a period of time (typically 5 seconds) before initiating a backflush cycle. The controller will automatically display the status screen if a backflush cycle is initiated or if the pressure differential set-point is reached.

## Adjustable Values

The following screens contain values that are operator adjustable. The controller's preset values may not be the recommended values. These values should be adjusted to meet the filter's backflush requirements. Reference the filter manufacturer's owner's manual for further information.

**Backflush Interval:** The operator-defined interval at which the system will initiate an automatic backflush cycle. The backflush frequency timer resets after any backflush cycle occurs (by timer, PD gauge, or operator). This value is adjustable from 1 minute to 1000 hrs. Setting both values to zero will turn off the backflush timer.

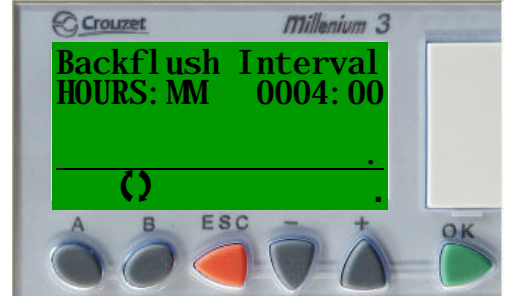

**Backflush Duration:** The time allotted for each individual filter station to backflush. On Air Assist systems, the backflush duration is limited to the amount of water in the reservoir and the amount of compressed air. This value is adjustable from 3 to 10 seconds.

**Air Delay Time:** The time period between the actuation of the backflush valves and the opening of the air injection valve. This time allows the 3-way valves to move into backflush mode before the compressed air is released to backflush the filter. This value is adjustable from 0.5 to 5 seconds (typically set to 1 second).

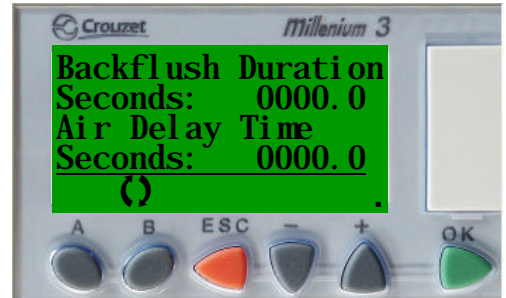

**Reservoir Vent Time:** The air-assist system utilizes stored filtered water for backflushing. The *Water Reservoir* must be refilled after a filter is backflushed. To refill the reservoir, air must be vented. Therefore, the *Reservoir Vent Time* is the time allowed for the water reservoir to refill after a backflush cycle. This value is adjustable from 5 to 120 seconds. This time is typically set between 15 and 40 seconds depending upon the reservoir size and water pressure.

**Dwell Time:** The amount of time allotted between the end of the backflush cycle for one filter station and the start of the backflush cycle for the next filter station in sequence. For Air Assist systems, the dwell must be set to allow sufficient time for an air compressor to fill the main air tank to completely. This value is adjustable from 0 to 300 seconds and is typically set between 15 to 60 seconds depending on the air supply.

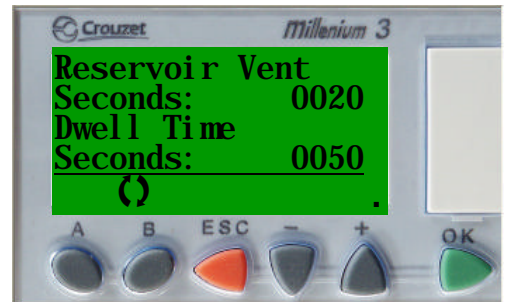

**Water Reservoir:** The *Water Reservoir* stores filtered water which is used for backflushing the filter. After a filter backflush, the reservoir is automatically refilled (as set per the *Reservoir Vent Time*). The water reservoir will always vent on system start up, main pump start and after every backflush. In addition the Dwell Time will always work in the same way. It is used to add the time for an air compressor to build up pressure in the main air tank.

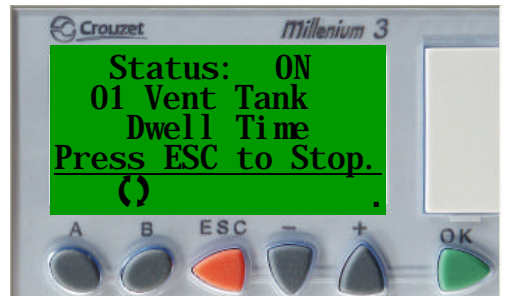

## Controller Feedback

The following screens provide system feedback. This allows the operator to monitor when and how the backflush cycle is occurring. It is typically recommended that the operator adjust the backflush frequency timer so that the system backflushes by time just before the pressure differential set-point is reached.

### Backflush Counters

**Trip:** The number of backflush cycles that have occurred since the counter was last reset. This includes cycles initiated both manually and automatically. This counter can be reset by pressing the **ESC** button from the *Backflush Counters* screen.

**Life:** The number of backflush cycles that have occurred in the controller's lifetime. This includes cycles initiated both manually and automatically. This counter cannot be reset.

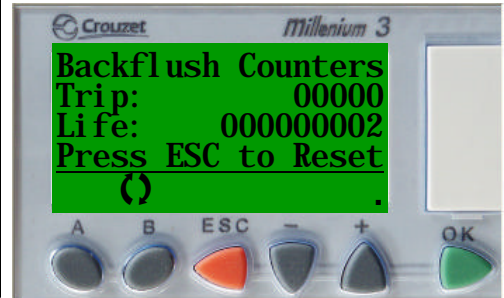

**Time Since Last Backflush:** The amount of time that has elapsed since the system last backflushed. The time displayed is in hours and minutes (example: 00011:30 is 11 hours and 30 minutes). This value does not include the elapsed time when the backflush frequency timer is off (either when the *Status Screen* reads *Status: Off* or when the controller is physically switched off). This screen also displays how the last backflush was triggered. There are three possibilities:

- 1) *Operator* - the backflush was manually triggered by an operator via the status screen.
- 2) *Timer* - the backflush was triggered by time as set on the backflush frequency screen.
- 3) *PD gauge* - the backflush was triggered by a high pressure differential, as set on the PD gauge mounted below the controller enclosure.

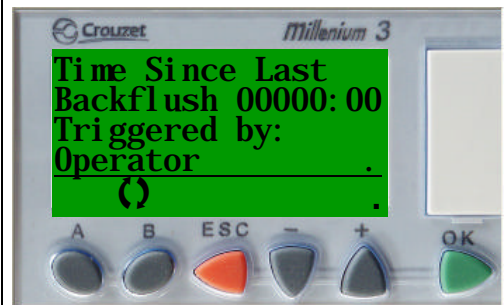

## Warranty Information

### Limited Warranty

Upon purchase, users of Miller-Leaman's *MAXIM* product agree to the following terms, conditions, and limitations of warranty and liability coverage.

Miller-Leaman warrants this product to be free from original defects for one year from the date of original sale. The manufacturer will replace, free of charge, any part found defective under normal use and service within the guarantee period, provided the product is installed, used, and maintained in accordance with any applicable instructions or limitations issued by Miller-Leaman. Components supplied as replacement parts are warranted for (90) days from the date of shipment.

The manufacturer assumes no liability for incidental or consequential damage sustained in the adoption or use of our engineering data, service, or products. Liability is therefore limited to the repair of the products manufactured by Miller-Leaman, Inc. No agent or representative of Miller-Leaman has the authority to waive or add to this agreement. Altered products or use of products in a manner not intended shall void this warranty.

For warranty repair/replacement, please contact Miller-Leaman to obtain an RMA number. All defective items should be sent freight pre-paid to:

Miller-Leaman, Inc.  
800 Orange Avenue  
Daytona Beach, FL 32114  
(386)248-0500 Phone / (386)248-3033 Fax  
E:mail: [sales@millerleaman.com](mailto:sales@millerleaman.com)  
Web Address: [www.millerleaman.com](http://www.millerleaman.com)

Record your MAXIM controller serial number in the space below and retain it for warranty purposes or technical questions. The serial number is located on the left side of the controller enclosure.

**Serial #** MLI-M\_\_\_\_\_-\_\_\_\_\_