

GENERAL SPECIFICATIONS	
DESIGN FLOW (GPM)	750
MAX PRESSURE (PSI)	150
FILTRATION AREA (SQ IN)	745
DRY WEIGHT (LBS)	168
VOLUME (US GAL)	34
MAX TEMP (°F)	135

MATERIALS		
HOUSING / SCREEN FRAME		304SS
SCREEN		316SS
GASKETS		EPDM
ELBOW & RISER PIPE		304SS

RINSE NOZZLE REQUIREMENTS	
PRESSURE (PSIG)	60
FLOW (GPM)	50

CONICAL FILTER ELEMENT		
PERFORATED SCREEN		TBD
MESH SCREEN		TBD
SCREEN HEIGHT (IN)		22.32

NOTES

CLEARANCE ABOVE STRAINER EQUAL TO SCREEN HEIGHT REQUIRED FOR SERVICE

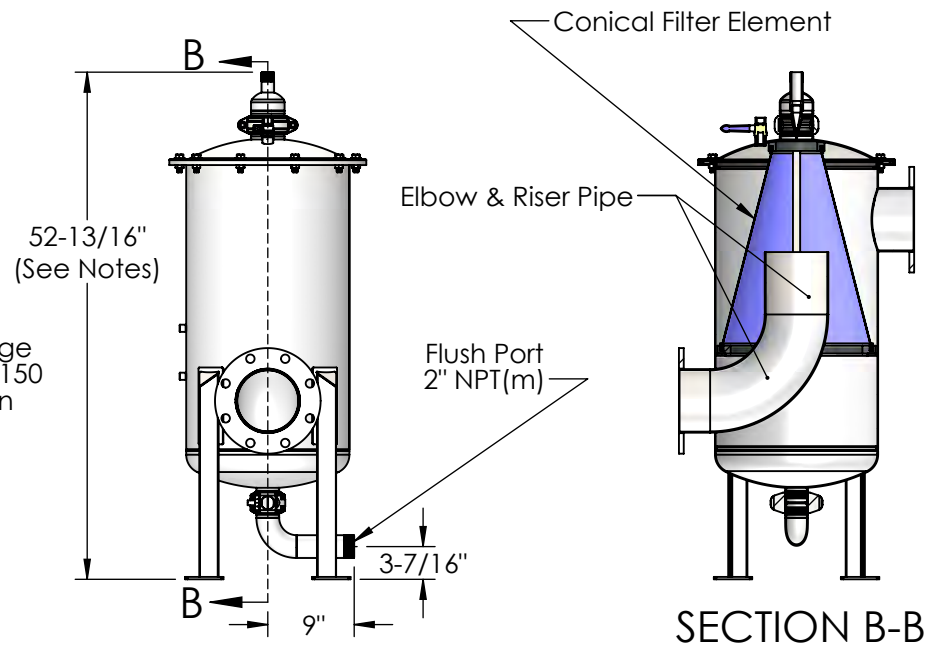
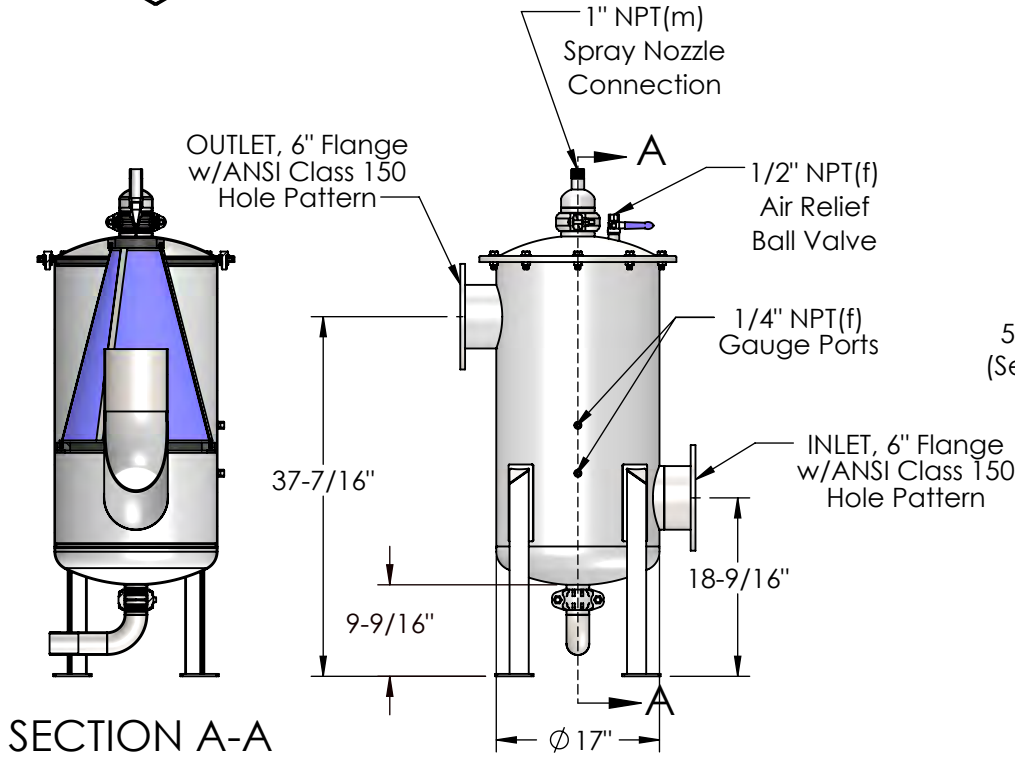

PRODUCT SPECIFICATION



800 Orange Avenue, Daytona Beach, FL 32114

Dimensions are for reference only.

CUST. REF.	
PREV. MOD.	
ENG. REF.	ML20430-F-R
DWG. DATE	3/30/21

SERIES:	THOMPSON	MODEL:	STRAINER
CONFIGURATION:		MLS-06BR-FSR3-304E	